

# Carrello ACE 7

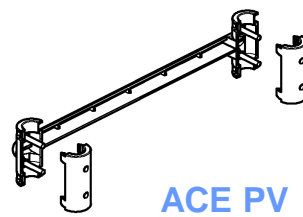

ACE PV

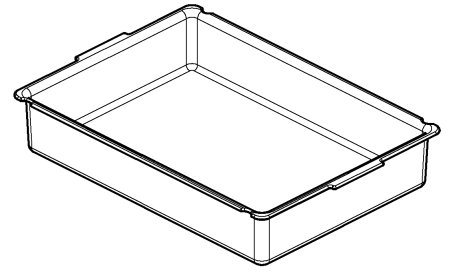

ACE 121

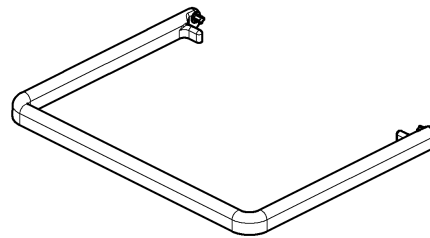

ACE SVM

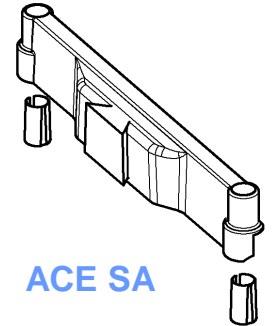

ACE SA

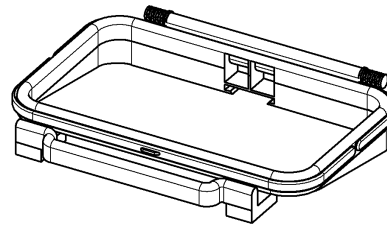

ANTA 103

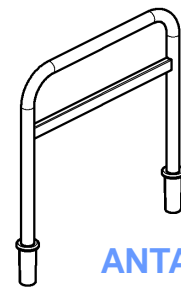

ANTA 118R

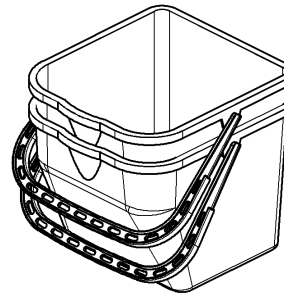

RS EVO 124

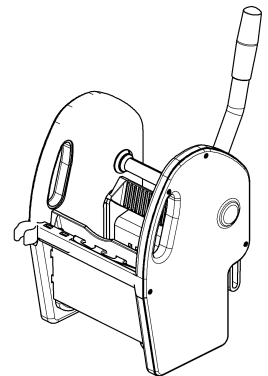

RSA 500

Cod.	Descrizione	Pz
ACE 101	Base centrale con 4 ruote Ø 100 mm piroettanti	1
ACE MR	Piantone H. 845 mm rilsan	2
ACE 118R	Supporto strizzatore rilsan	1
ACE PV	Traverso completo per piantone	4
ACE 121	Vaschetta mm 490x350x90	3
ACE SVM	Supporto vaschetta sostegno sacco	1
ACE SA	Supporto portasacco	1
ANTA 103	Supporto sacco lt.120 completo	1
RS EVO 124	Secchio lt.15	2
RSA 500	Strizzatore New Line	1
ACE 113	Base reggiscopa	2
ACE 120	Portamanico	1

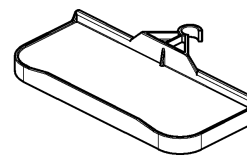

ACE 113



ACE 120

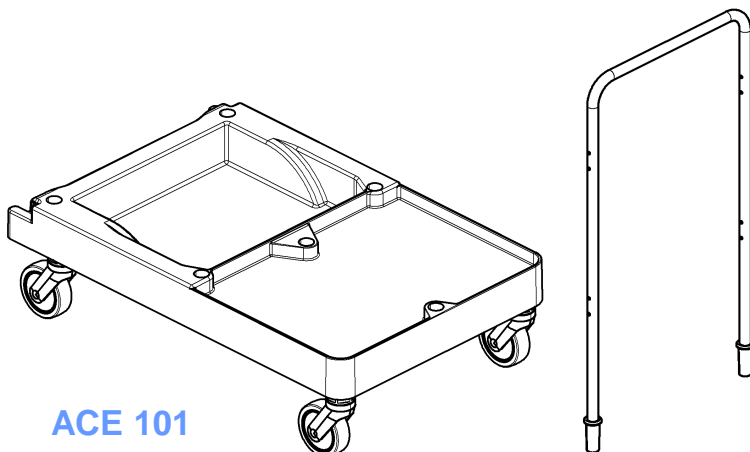

ACE 101

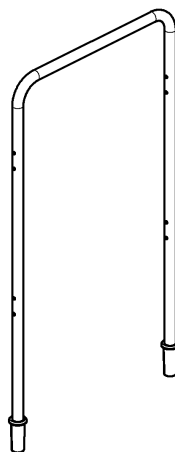

ACE MR

## Optional

Cod.	Descrizione	Pz
ANTA 128	Coperchio lt.120	1
ANTA 125	Secchio lt.6	4

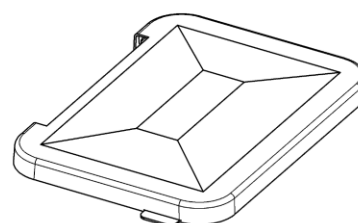

ANTA 128

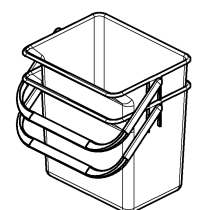

ANTA 125

# ISTRUZIONI PER L'ASSEMBLAGGIO - INSTRUCTIONS FOR ASSEMBLY

